

Instruction 510-0398

05-31-16

Copyright © 2016

Version 1

by S&S® Cycle, Inc.

All rights reserved.
Printed in the U.S.A.

S&S® Cycle, Inc.

14025 Cty Hwy G PO Box 215

Viola, Wisconsin 54664

Phone: 608-627-1497 • Fax: 608-627-1488

Technical Service Phone: 608-627-TECH (8324)

Technical Service Email: sstech@sscycle.com

Website: www.sscycle.com



Installation Instructions: S&S Hydraulic Cam Chain Tensioners

DISCLAIMER:

Many S&S parts are designed for high performance, closed course, racing applications and are intended for the very experienced rider only. The installation of S&S parts may void or adversely affect your factory warranty. In addition such installation and use may violate certain federal, state, and local laws, rules and ordinances as well as other laws when used on motor vehicles used on public highways. Always check federal, state, and local laws before modifying your motorcycle. It is the sole and exclusive responsibility of the user to determine the suitability of the product for his or her use, and the user shall assume all legal, personal injury risk and liability and all other obligations, duties, and risks associated therewith.

NOT LEGAL FOR SALE OR USE IN CALIFORNIA ON ANY POLLUTION CONTROLLED MOTOR VEHICLES

SAFE INSTALLATION AND OPERATION RULES:

Before installing your new S&S part it is your responsibility to read and follow the installation and maintenance procedures in these instructions and follow the basic rules below for your personal safety.

- Gasoline is extremely flammable and explosive under certain conditions and toxic when breathed. Do not smoke. Perform installation in a well ventilated area away from open flames or sparks.
- If motorcycle has been running, wait until engine and exhaust pipes have cooled down to avoid getting burned before performing any installation steps.
- Before performing any installation steps disconnect battery to eliminate potential sparks and inadvertent engagement of starter while working on electrical components.
- Read instructions thoroughly and carefully so all procedures are completely understood before performing any installation steps. Contact S&S with any questions you may have if any steps are unclear or any abnormalities occur during installation or operation of motorcycle with a S&S part on it.
- Consult an appropriate service manual for your motorcycle for correct disassembly and reassembly procedures for any parts that need to be removed to facilitate installation.
- Use good judgment when performing installation and operating motorcycle. Good judgment begins with a clear head. Don't let alcohol, drugs or fatigue impair your judgment. Start installation when you are fresh.
- Be sure all federal, state and local laws are obeyed with the installation.
- For optimum performance and safety and to minimize potential damage to carb or other components, use all mounting hardware that is provided and follow all installation instructions.
- Motorcycle exhaust fumes are toxic and poisonous and must not be breathed. Run motorcycle in a well ventilated area where fumes can dissipate.

IMPORTANT NOTICE:

Statements in this instruction sheet preceded by the following words are of special significance.



WARNING

Means there is the possibility of injury to yourself or others.



CAUTION

Means there is the possibility of damage to the part or motorcycle.

NOTE

Other information of particular importance has been placed in italic type.

S&S recommends you take special notice of these items.

WARRANTY:

All S&S parts are guaranteed to the original purchaser to be free of manufacturing defects in materials and workmanship for a period of twelve (12) months from the date of purchase. Merchandise that fails to conform to these conditions will be repaired or replaced at S&S's option if the parts are returned to us by the purchaser within the 12 month warranty period or within 10 days thereafter.

In the event warranty service is required, the original purchaser must call or write S&S immediately with the problem. Some problems can be rectified by a telephone call and need no further course of action.

A part that is suspect of being defective must not be replaced by a Dealer without prior authorization from S&S. If it is deemed necessary for S&S to make an evaluation to determine whether the part was defective, a return authorization number must be obtained from S&S. The parts must be packaged properly so as to not cause further damage and be returned prepaid to S&S with a copy of the original invoice of purchase and a detailed letter outlining the nature of the problem, how the part was used and the circumstances at the time of failure. If after an evaluation has been made by S&S and the part was found to be defective, repair, replacement or refund will be granted.

ADDITIONAL WARRANTY PROVISIONS:

- (1) S&S shall have no obligation in the event an S&S part is modified by any other person or organization.
- (2) S&S shall have no obligation if an S&S part becomes defective in whole or in part as a result of improper installation, improper maintenance, improper use, abnormal operation, or any other misuse or mistreatment of the S&S part.
- (3) S&S shall not be liable for any consequential or incidental damages resulting from the failure of an S&S part, the breach of any warranties, the failure to deliver, delay in delivery, delivery in non-conforming condition, or for any other breach of contract or duty between S&S and a customer.

Installation Steps

1. Secure the motorcycle on a lift and elevate the rear tire. Shift transmission into high gear, and remove the spark plugs.
2. Refer to the factory service manual for cam chest disassembly procedure. Remove cam cover, pinion and cam drive sprockets and outer drive chain. Remove the cam support plate, cams, and oil pump.

NOTE - There is no need to remove cams from the cam support plate unless cams are to be changed.

3. Wash chain tensioner parts in solvent and blow dry. Assemble S&S cam chain tensioners according to the part order shown in **Picture 1**.

NOTE - If cam chain tensioners are being reinstalled after engine has been run, all oil must be cleaned out, or installation will be more difficult.

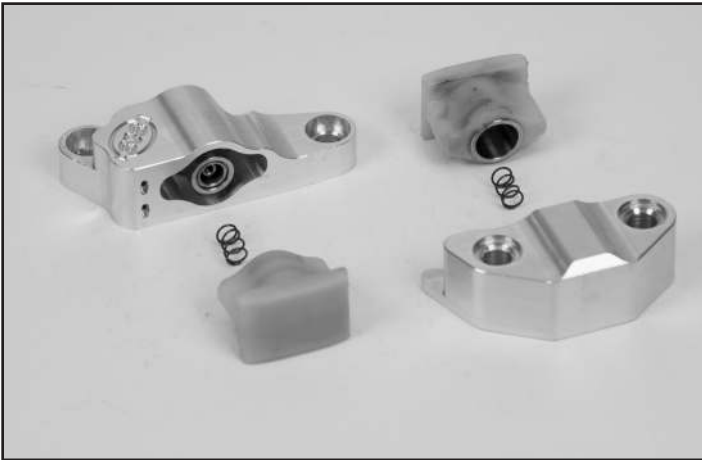

Picture 1

4. Verify that the timing marks on the inner cam sprockets are correctly aligned. Refer to factory service manual or cam installation instructions. See **Picture 2**.

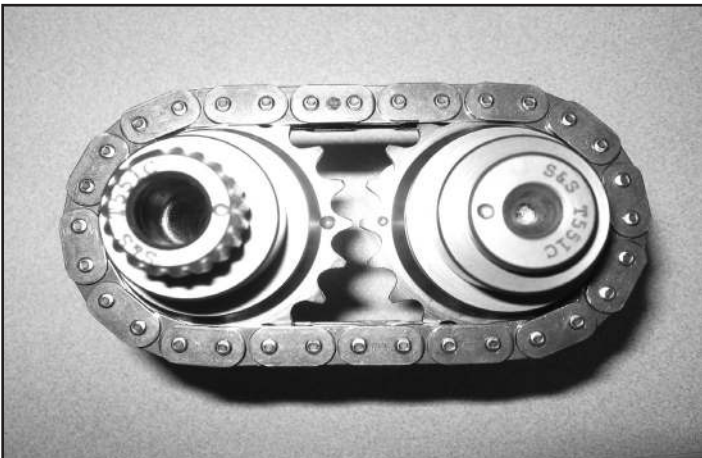

Picture 2

5. Install inner cam chain tensioner assembly. Press the shoe of the tensioner against the chain to compress the spring inside the tensioner assembly. Apply blue thread locker to the 1/4-20 x 1 1/8" Torx fasteners and install in place of stock hardware. Tighten to 100 in-lb. See **Picture 3**.

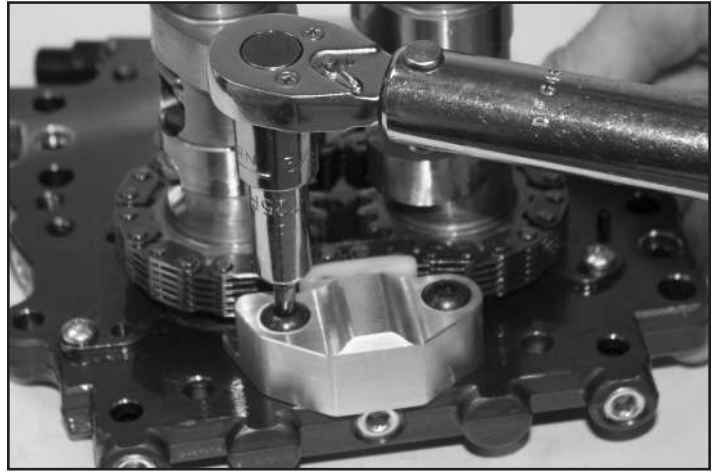

Picture 3

6. Apply engine oil to the supplied oil pump scavenge o-ring, and install in crankcase. Install the oil pump in the crankcase. If installing a new oil pump refer to the instructions supplied with the pump.
7. Apply blue thread locker to existing fasteners and install the cam support plate and cams. Tighten fasteners to 100 in-lb in the sequence shown in **Figure 1**.

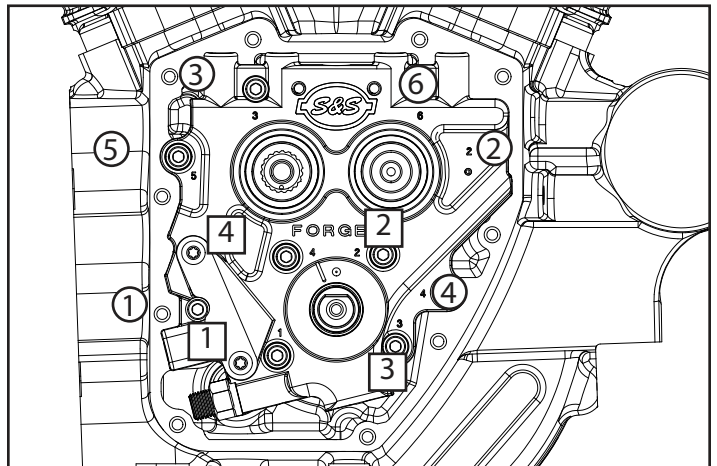

Figure 1

8. Apply blue thread locker to oil pump mounting bolts and install. Do not tighten yet.
9. Refer to **Figure 1** for proper torque sequence. While rotating the engine, alternately tighten bolts 1 and 2 (shown in squares) until the bolts are snug. Tighten bolts 3 and 4 until they are snug. Finally, torque the four bolts in the sequence shown to 100 in-lbs. This procedure ensures that the oil pump is properly centered.
10. Install spacer over the end of the rear cam, and install the rear cam drive sprocket, and hand tighten the bolt.
11. Install the pinion sprocket and hand tighten the bolt.
12. Insert a sprocket locking tool and tighten both bolts to 15 ft-lb.

13. Push both sprockets toward the left side of the motorcycle to take up any end play. Lay a straight edge over the sprocket faces to determine correct sprocket alignment. If the gap between the straight edge and the lower of the sprockets is less than .010", no adjustment is necessary. If sprockets are out of alignment by more than .010" a different spacer must be installed so the sprockets are in line. Refer to factory service manual.

14. Remove both sprockets.

15. Install outer drive chain and sprockets. Make sure the timing marks on the pinion and rear cam drive sprocket are lined up. **Picture 4** shows 2007-'16 style chain and sprockets. **Picture 5** shows the 1999-'06 style "silent" chain and sprockets. Stock early chains and sprockets may be used with S&S hydraulic cam chain tensioners when also installing an S&S cam support plate.

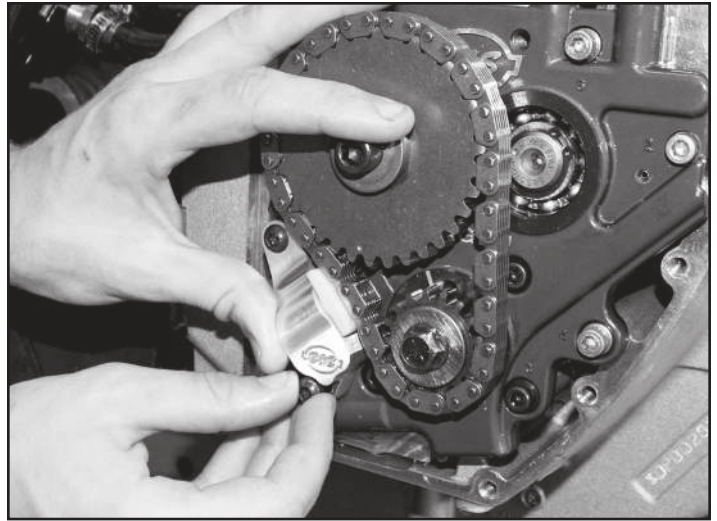

Picture 6

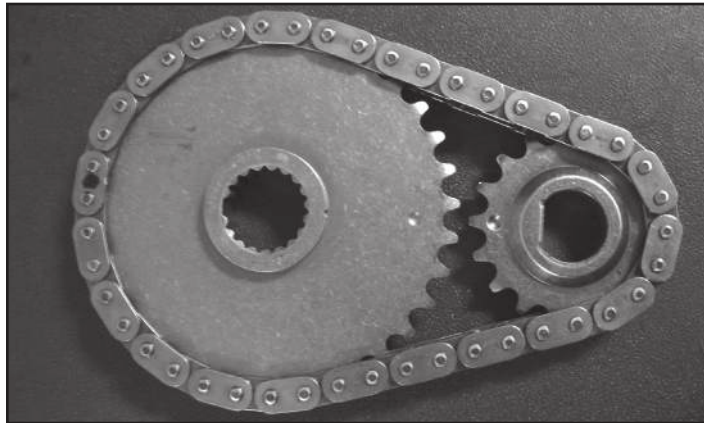

Picture 4

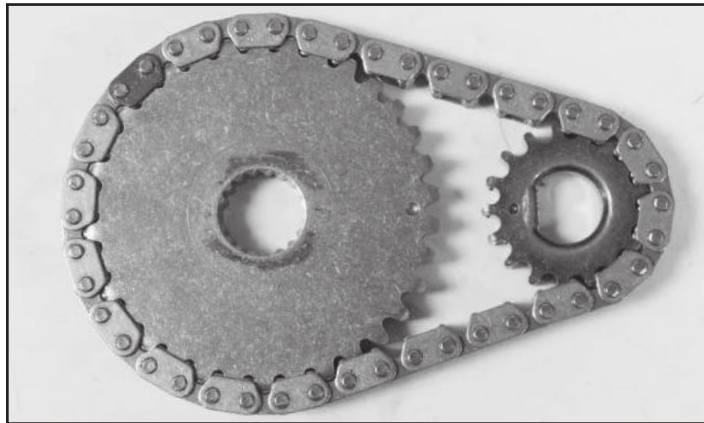

Picture 5

18. Place clay or putty on the inside of the cam cover in the area near the outer hydraulic chain tensioner, and install on cam chest with the intended gasket. Remove and inspect the amount of clearance between the cam chain tensioner and the cam cover. If necessary, grind material from the cover to provide a minimum of .030" clearance. This check is especially important when converting 1999-'06 engines from spring loaded chain tensioners to hydraulic tensioners, and for engines with aftermarket cam covers.

19. Reassemble the cam chest and pushrods using the procedure in the factory service manual or instructions supplied with any aftermarket components used.

16. Insert sprocket locking tool. Apply blue thread locker to the bolts and tighten the pinion sprocket bolt to 25 ft-lb and the cam sprocket bolt to 34 ft-lb.

17. Apply blue thread locker to the two 1/4-20 x 3/4" Torx head bolts, and install the outer chain tensioner loosely with one bolt. Press the tensioner shoe against the drive chain to compress the spring inside the tensioner. Install the second bolt, and tighten both bolts to 100 in-lb. **See Picture 6.**

