











**MORE POWER : LESS NOISE**



Congratulations, you have purchased the finest exhaust system for your motorcycle on the market. Your Vance & Hines exhaust system is designed and crafted for maximum performance, a perfect fit, a great sound and unbeatable style. Please follow the installation instructions below and if you have any questions, please call our technical support line at (562) 926-5291.

Attention installer (if other than owner), please forward this instruction sheet to the owner of this product. These instructions contain valuable information to the end user.

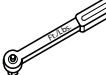
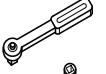
**TOOLS  
REQUIRED**

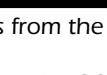
-  Flat Blade Screwdriver
-  5/16" Nut Driver
-  1/2", 9/16, 7/8" or 22mm Wrenches
-  3/16", 5/16" Allen Wrenches
-  T30 Torx Wrench
-  Snapping Pliers
-  ft/lb, in/lb Torque Wrenches
-  3/8" drive Ratchet
-  1/2", 9/16" Sockets
-  3/8" Drive Extensions

**READ ALL INSTRUCTIONS BEFORE BEGINNING INSTALLATION**

**STOCK EXHAUST  
SYSTEM REMOVAL**

- NOTE:** These instructions are written for late model motorcycles equipped with O2 sensors. If you are installing this system on a motorcycle not equipped with O2 sensors you will need to contact our Customer Service Dept. to purchase an O2 sensor block off kit P/N 16925
1. Find and unplug the O2 sensor wires from the wiring harness and remove the reusable clamp or nylon cable tie (whichever is being used) holding front wire to frame. Feed the end of the wires through the frame so they are free from the motorcycle. NOTE: Pay attention to wire routing for re-installation.
  2. Loosen the heat shield clamps on both the front and rear exhaust pipes. This allows easier access to the head pipe mounting nuts.
  3. Remove the two head pipe mounting nuts from each flange, located at the cylinder head.
  4. Remove the clamp bolt which mounts the rear head pipe to the belt drive cover bracket.
  5. Remove the two bolts from each muffler body where they attach to the

- mounting bar. Carefully remove exhaust pipes from the motorcycle and set aside.
6. Using a 7/8" or 22mm wrench, carefully remove the O2 sensors from the stock head pipes and save for re-use with the new system.
7. Remove the drive belt cover and take the bracket off the rear cover bolt, the bracket will not be re-used.
8. Loosen and remove the brake rod at the rear eyelet using a T30 torx driver.
9. Remove the three mount bolts and washers attaching the exhaust mounting bar (save hardware for re-use).
10. Carefully remove exhaust port flanges and circlips from the stock exhaust system using snapping pliers. NOTE: Replace bent or damaged circlips. Check exhaust port gasket condition. Recommended replacement exhaust port gaskets, Harley part number: 17048-98 or 65324-83A.

**FIGURE 1**



**FIGURE 2**

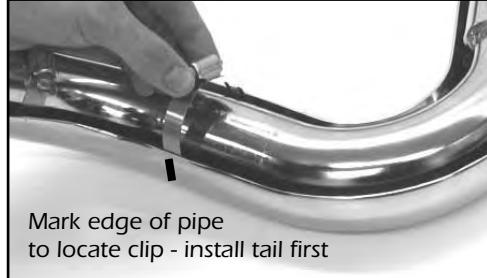

**FIGURE 3**

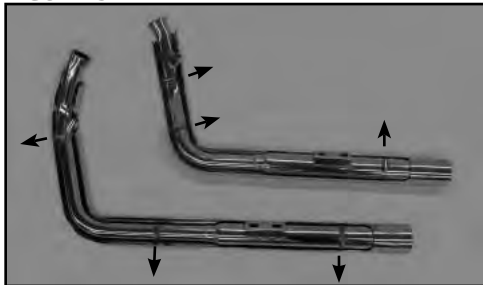

**FIGURE 4**



**FIGURE 5**



**FIGURE 6**

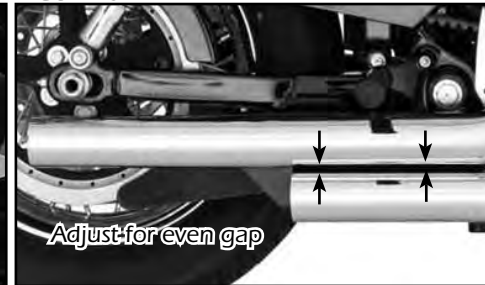

1. Install and tighten supplied mounting bracket (stamped 356-P) (Figure 1) using stock washers and bolts. Torque to 30-33 Ft/Lbs. NOTE: Support the rear of the bracket during tightening to insure it is align with the bottom edge of frame
2. Re-install drive belt cover. Torque the 3/8" bolt to 30-33 Ft/Lbs. and the two 1/4" bolts to 80-120 In/Lbs.
3. Re-install brake rod eyelet using removable thread locking compound (Loctite® 243 recommended). Torque to 120-180 In/Lbs.
4. Remove header pipes and heat shields from protective packaging. Place each heat shield on a non-abrasive surface such as a blanket or carpet. Using a felt tip pen, mark outside edge of each heat shield to show location of mounting clips where hose clamps will loop through (Figure 2).
5. Lay head pipes into heat shields and loosely install hose clamps by feeding tail end of clamp into heat shield clips (Figure 2). Take note of screw head direction (Figure 3). Screw heads should be accessible when system is installed on motorcycle for adjustment purposes. Use #20 hose clamps on head pipes and #28 hose clamps on muffler bodies (supplied).
6. Apply a small amount of anti-seize compound to the threads of the O2 sensors and install them into the new head pipes. NOTE: Be careful not to get anti-seize on sensor tip, it may affect sensor function.
7. Install circlips and flanges from the stock system onto both new head pipes. (Figure 4)
8. Using stock flange nuts, carefully install head pipes into exhaust ports (Assistance may be required). NOTE: Do not tighten at this time.
9. Slide nut plates inside brackets welded to backside of muffler bodies (Figure 5). While holding nut plates in place, attach muffler bodies to mounting bracket 356-P using four 5/16"x 5/8" flange head bolts (supplied). Leave them loose at this time.
10. Tighten cylinder port exhaust flange nuts on front and rear cylinders while making sure pipes are parallel. (Figure 6)
11. Tighten the flange bolts on both mufflers and all heat shield clamps.
12. Plug O2 sensors back into wiring harness and route wires away from hot areas of motorcycle.
13. Re-install the reusable clamp or install a new nylon cable tie (supplied) to hold the front wire onto the frame in the original location.
14. Check for adequate clearance of all exhaust system components and motorcycle accessories prone to heat damage.
- 15. Be sure to tighten all hardware before starting motorcycle.**

### EXHAUST CARE - HELPFUL HINTS TO AVOID DISCOLORATION OF EXHAUST SYSTEM

1. When installing a new set of chrome pipes, make sure your hands are clean and free of oil. After installation, thoroughly clean pipes with a soft cloth and cleaning solvent that will leave no residue (chrome wax / polish, glass cleaner, alcohol, ammonia, etc...) before starting the motorcycle.
2. Avoid long periods of idling as this can cause discoloration.
3. Intake leaks can cause the engine to run lean and overheat, this could lead to discoloration.
4. Make sure there are no exhaust leaks at the junction of the exhaust pipes and cylinder head. We recommend replacing gaskets if they are worn.

### VANCE & HINES OPTIONAL ACCESSORIES

#### FUELPAK



#### FUEL MANAGEMENT:

Take the guess work out of fuel injection with Fuelpak Fuel Management. Contact your local dealer or call (562) 921-0071 to order. Visit [fuelpakfi.com](http://fuelpakfi.com) for more information. Fuelpak is intended for racing or off-highway use only, and is not legal for sale or use in California on pollution-controlled vehicles.

#### QUIET Baffle



Quiet baffle P/N 21869 is available for this system. The quiet baffle will lower the sound level by 2-3db on average. Contact your local dealer to order.

PLEASE NOTE: Every effort is made for Vance & Hines Exhaust Systems to provide improved cornering clearance. However, due to design and space limitations on some motorcycle models, ground and cornering clearance may not be improved and in some cases may be reduced. Be sure to follow proper installation instructions.



**PACKING LIST**

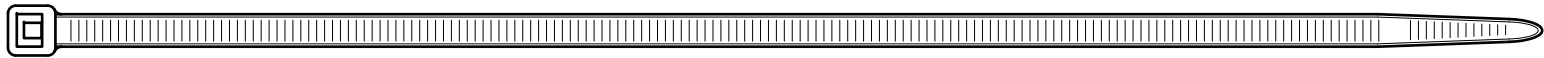

Nylon Cable Tie x 1

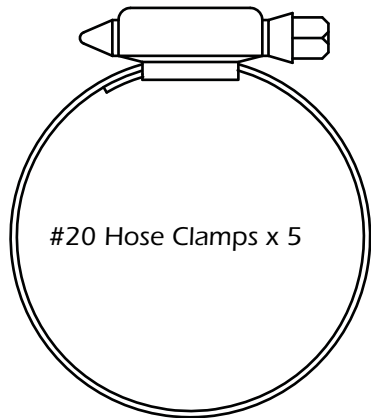

#20 Hose Clamps x 5

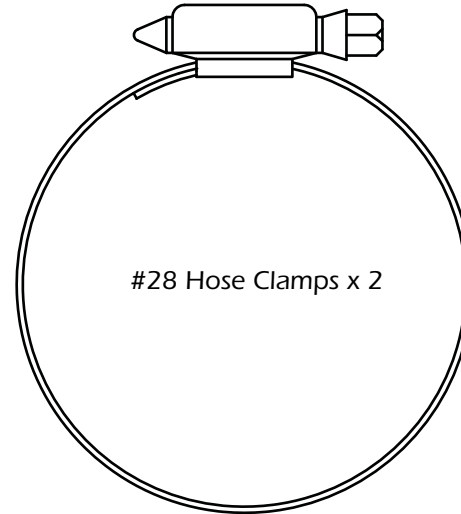

#28 Hose Clamps x 2

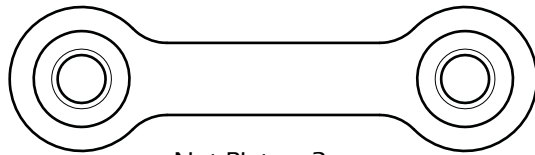

Nut Plate x 2

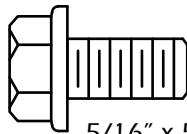

5/16" x 5/8" Flange Head Bolt x 4

**PARTS NOT SHOWN:**

356-P	Bracket	x1
D605FC	Front Header Assembly	x1
D606FC	Rear Header Assembly	x1
D605HC	Front Muffler Heat Shield	x1
D606HC	Rear Muffler heat Shield	x1

**MORE POWER : LESS NOISE**

ALL PARTS SHOWN ARE ACTUAL SIZE

**WARRANTY**

Vance & Hines exhaust systems are warranted against defects in material and workmanship for a period of 90 days from the date of purchase from an authorized dealer. This warranty does not cover discoloration of chrome finishes. This warranty is limited to the repair or replacement of a product proven to be defective from normal use. Vance & Hines exhaust systems are designed to fit and operate on OEM motor and chassis. This warranty does not cover any product subject to abuse, misuse, improper installation or modification.

## FUEL MANAGEMENT

**GET THE MOST OUT OF YOUR RIDING EXPERIENCE...**

AN AFTERMARKET EXHAUST SYSTEM IS ONLY YOUR FIRST STEP, NOW YOU NEED FUEL MANAGEMENT.

### **NOW YOU NEED FUELPAK.**

Your fuel injected Harley-Davidson® is equipped with an ECU (electronic control unit) that's programmed to deliver fuel to the motor based on an air/fuel ratio for a stock air filter and stock exhaust system. When you install a performance exhaust system, your airflow changes, so you need a fuel management system that adjusts your air/fuel ratio to match the changes. That fuel management system is Fuelpak. Fuelpak adds and takes away fuel, allowing for a more precise range of refinement in your air/fuel ratio. Get the perfect fuel management combination with your Vance & Hines exhaust system, get Fuelpak. For more information visit the tuning center at [fuelpakfi.com](http://fuelpakfi.com)

NOTICE: Fuelpak is intended for racing or off-highway use only, and is not legal for sale or use in California on pollution-controlled vehicles.



**MORE POWER : LESS NOISE**

**13861 ROSECRANS AVENUE / SANTA FE SPRINGS, CA 90670**  
**SALES: (562) 921-5388 / TECHNICAL: (562) 926-5291 / FAX: (562) 802-0110**  
**VANCEANDHINES.COM**